

A43(A), I78(B), O1(C)  
Certification ECU

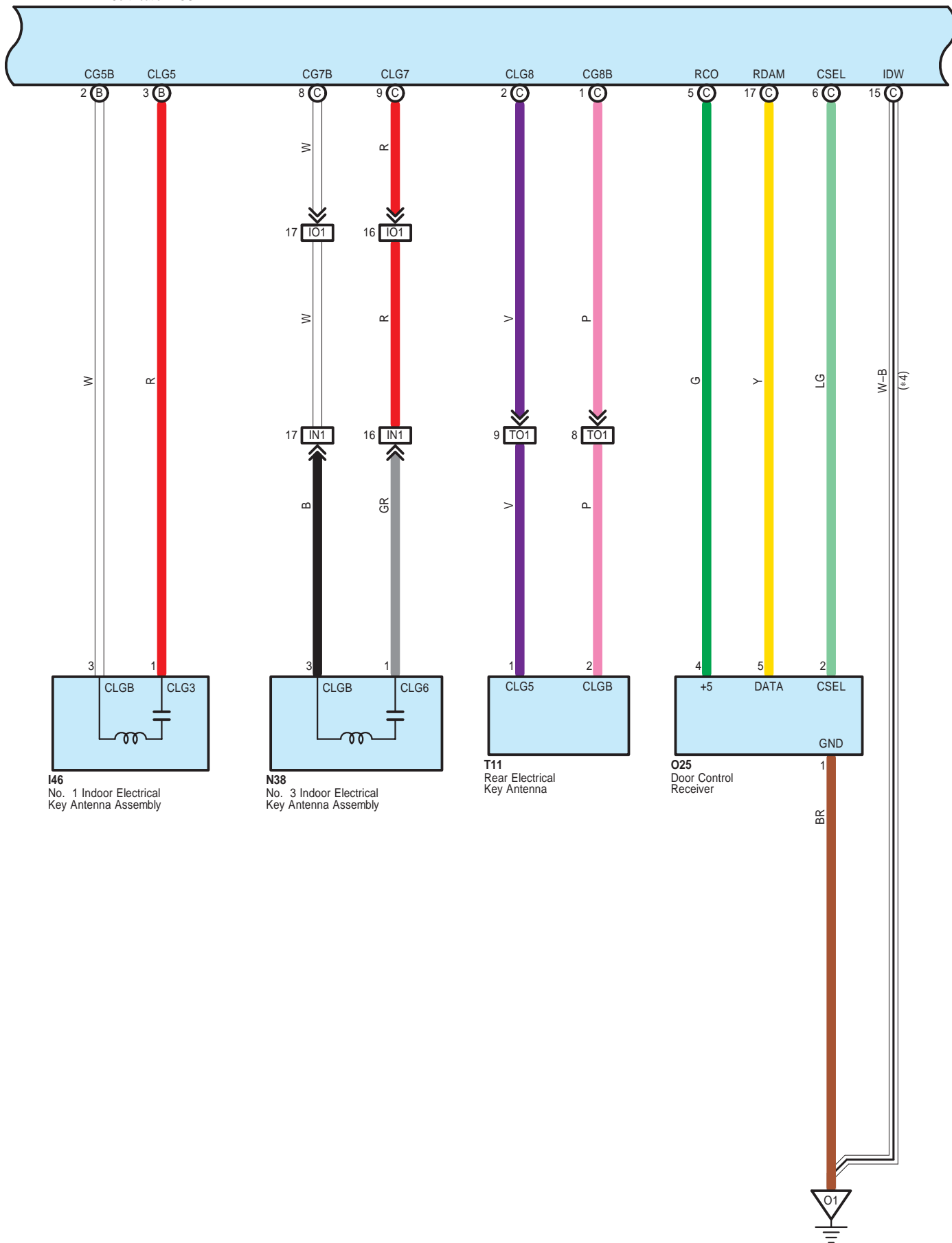

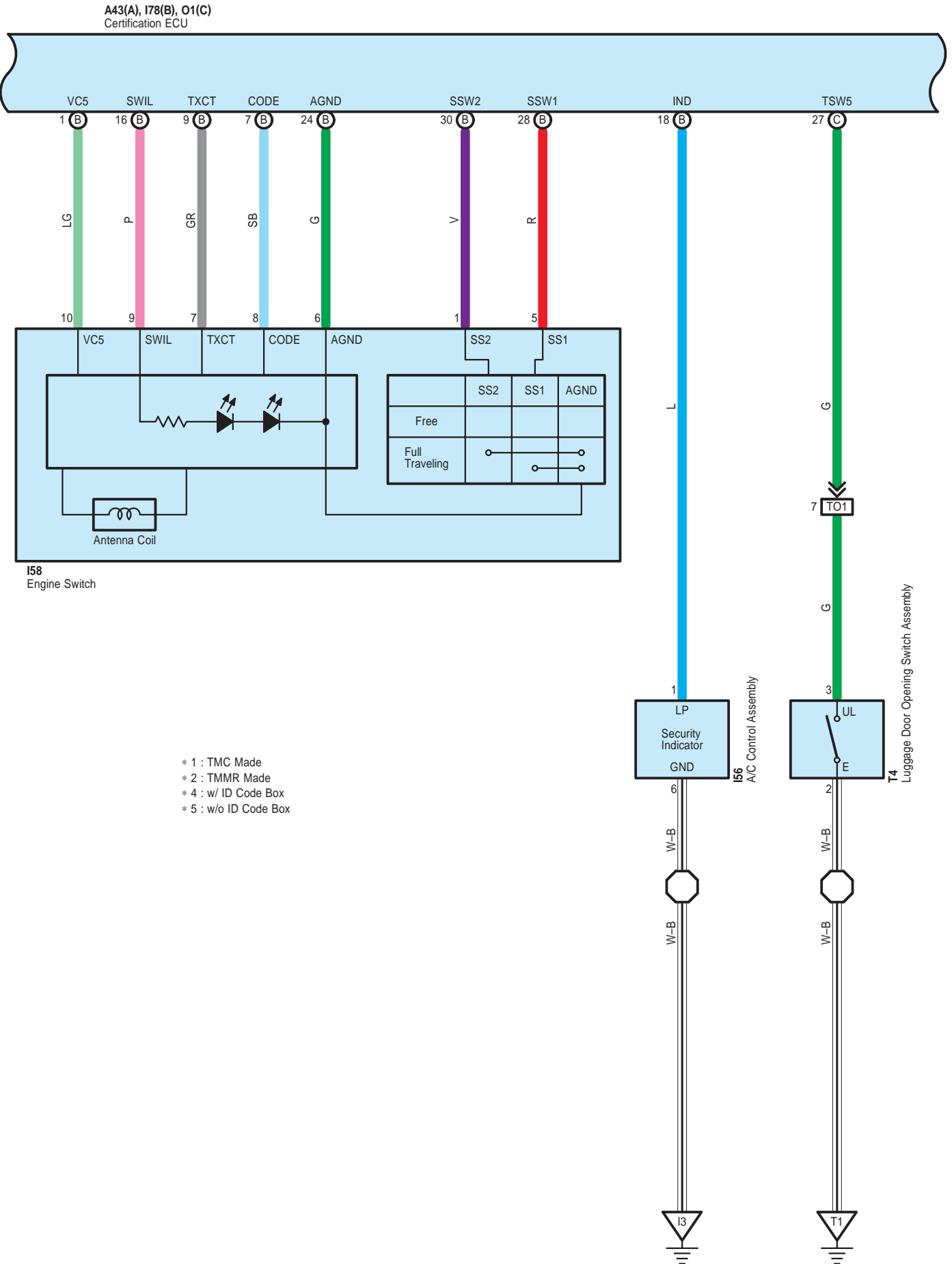

I58  
Engine Switch

I56  
A/C Control Assembly

T4  
Luggage Door Opening Switch Assembly

- \* 1 : TMC Made
- \* 2 : TMMR Made
- \* 4 : w/ ID Code Box
- \* 5 : w/o ID Code Box

A43(A), I78(B), O1(C)  
Certification ECU

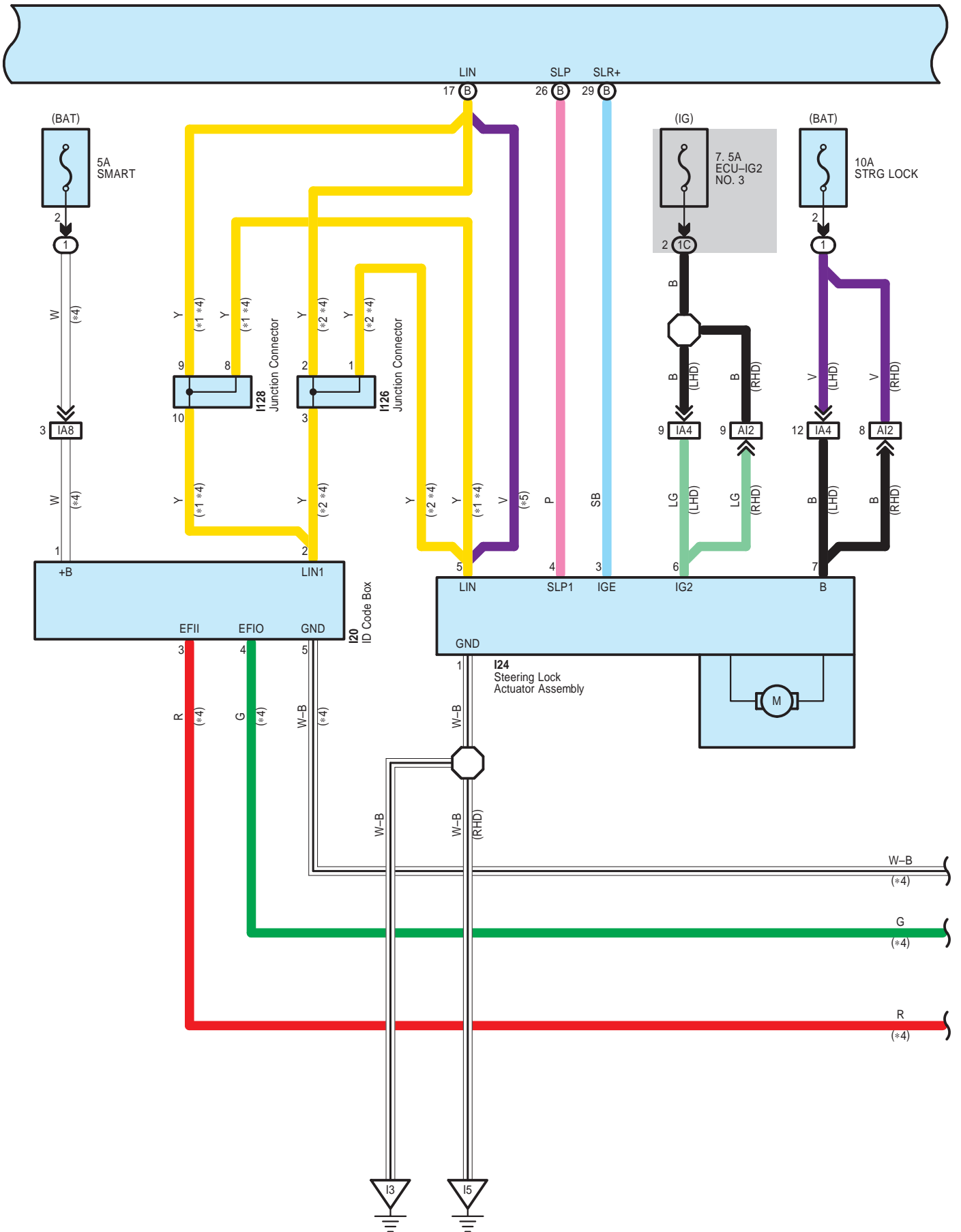

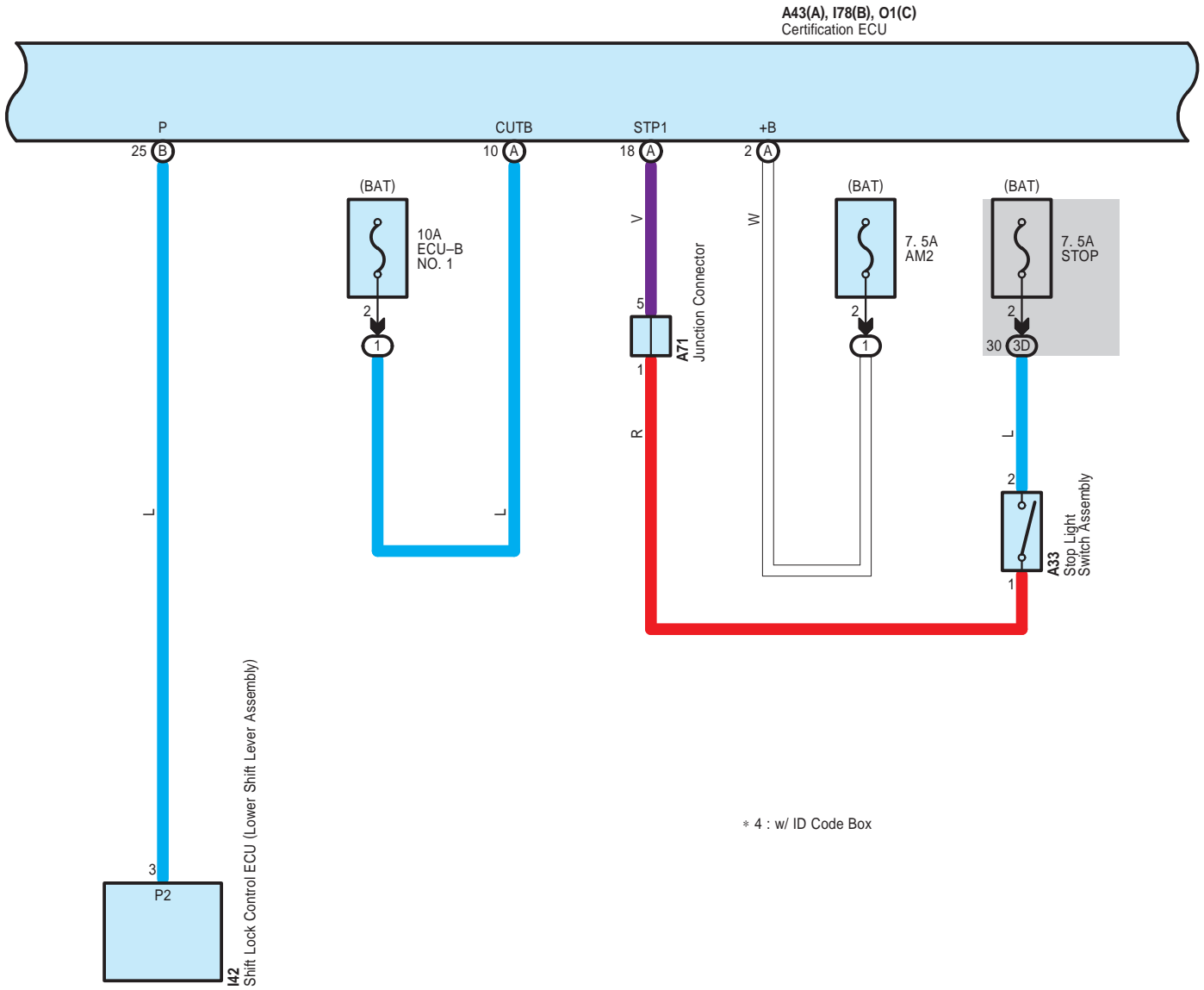

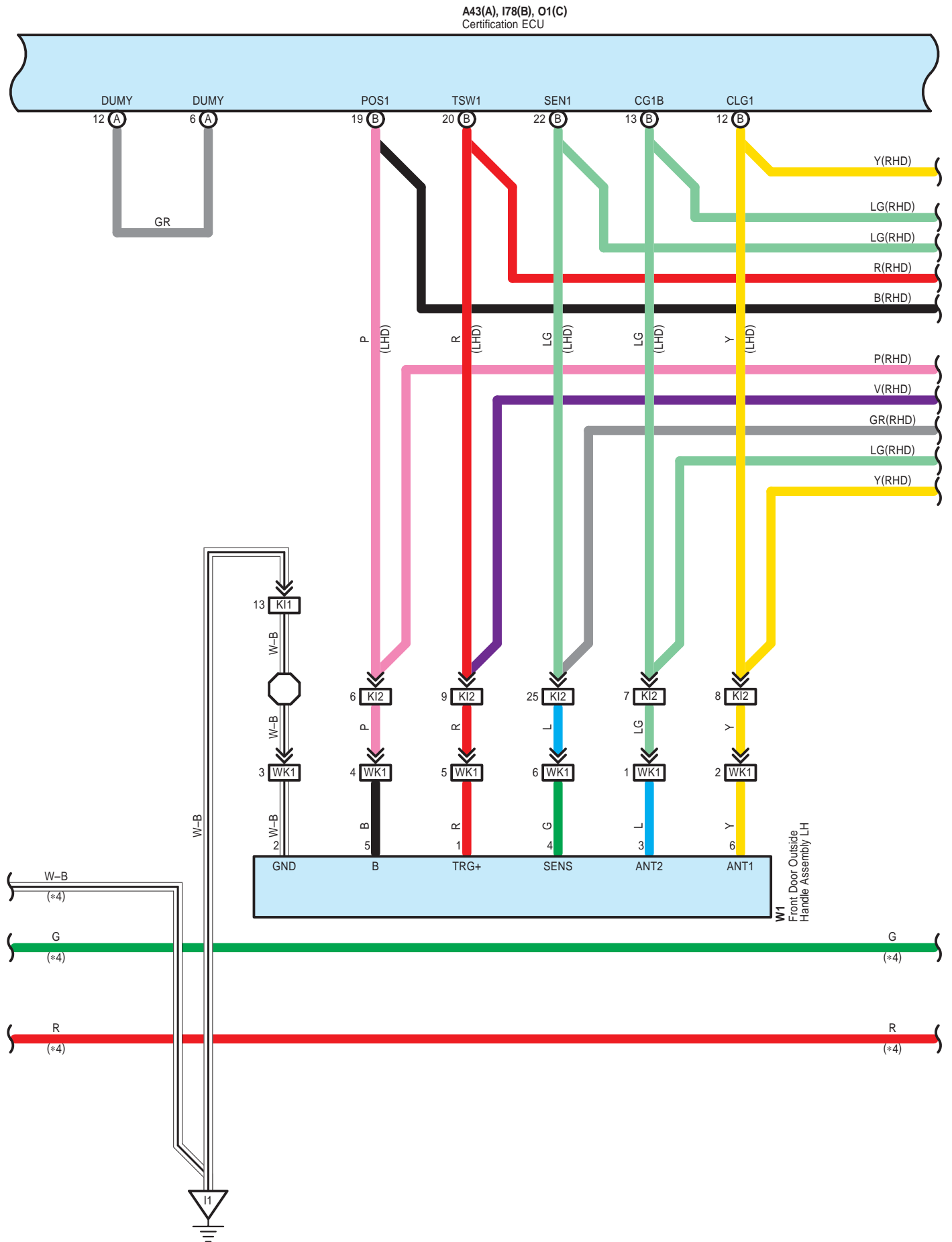

A43(A), I78(B), O1(C)  
Certification ECU

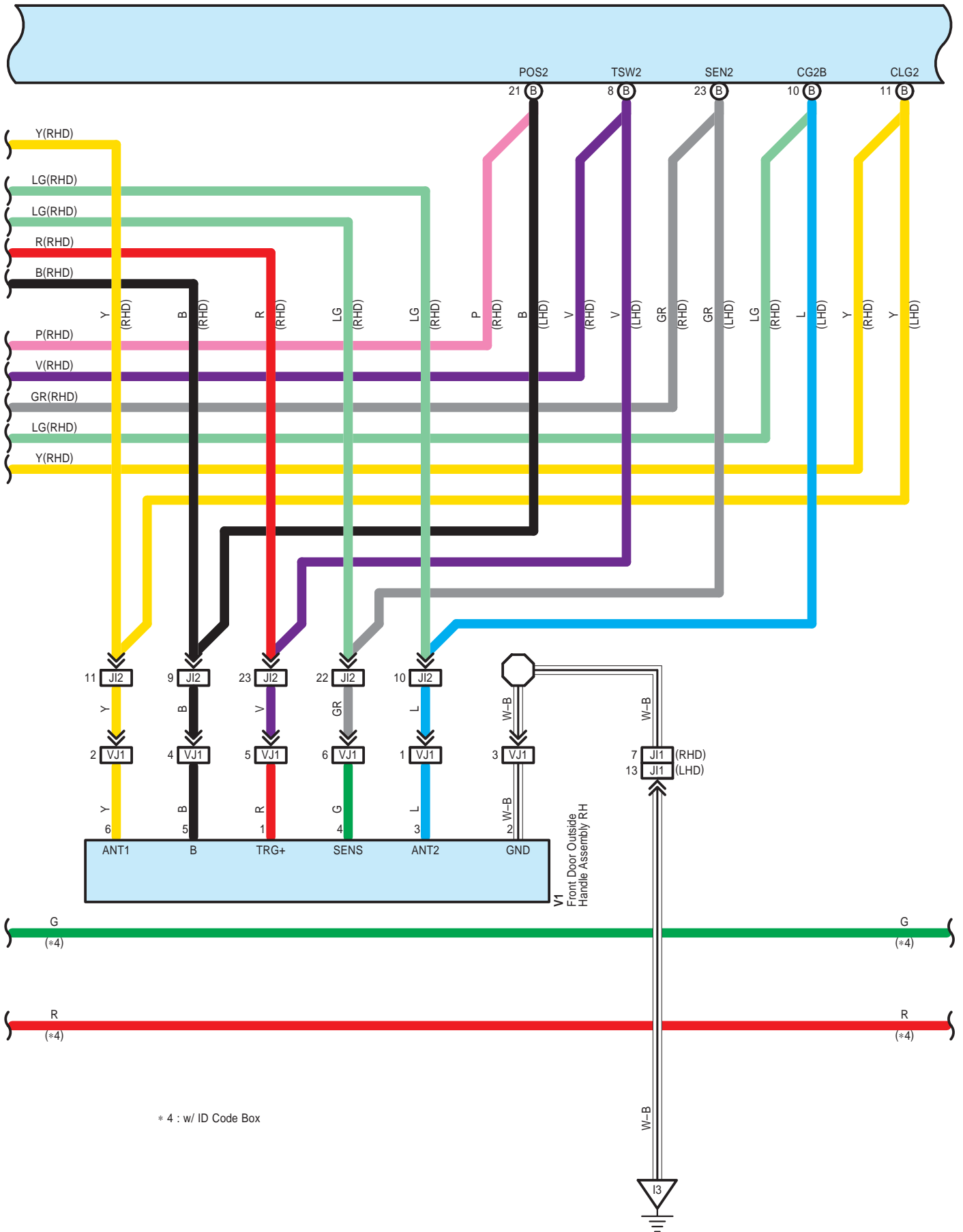

\* 4 : w/ ID Code Box

A43(A), I78(B), O1(C)  
Certification ECU

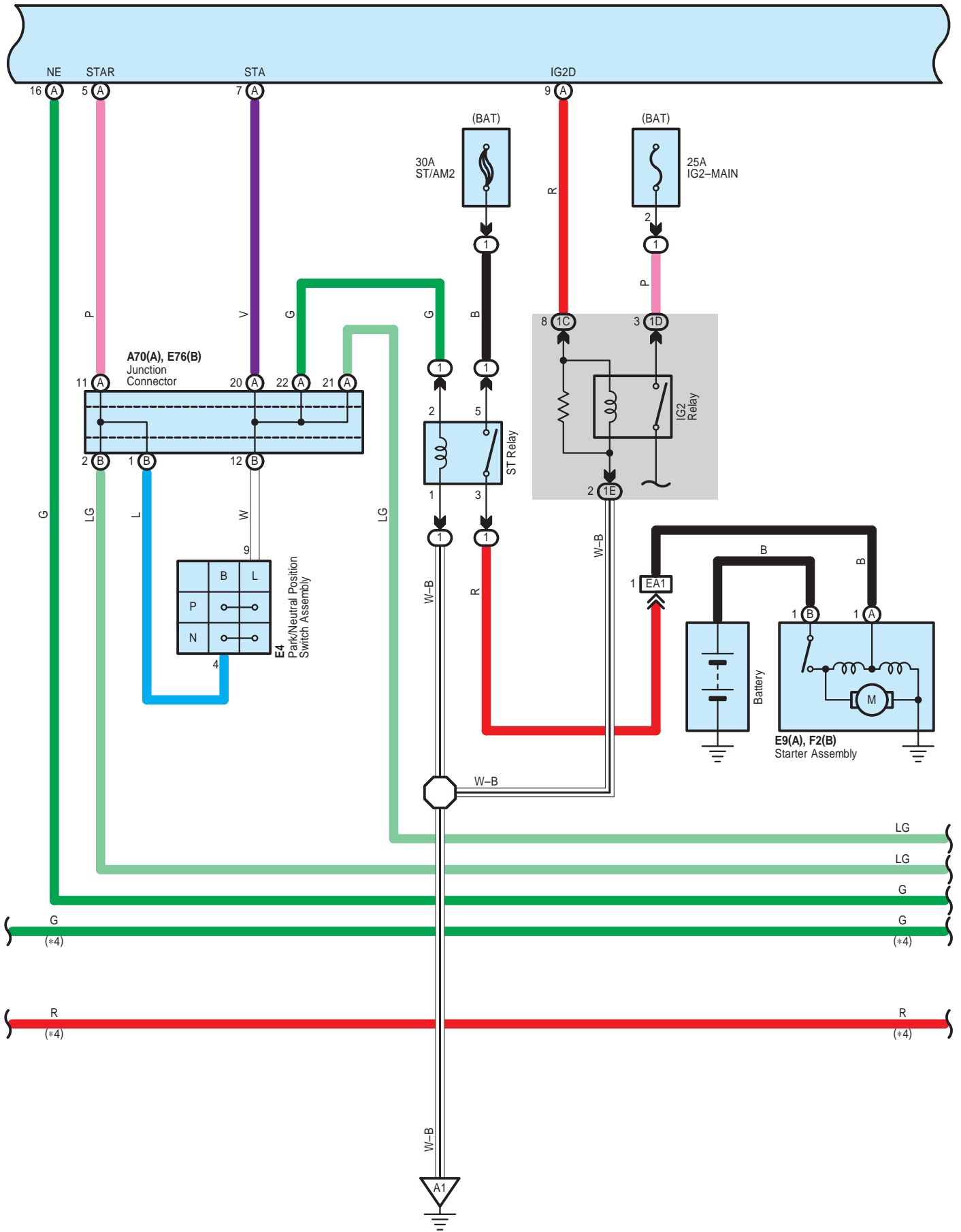



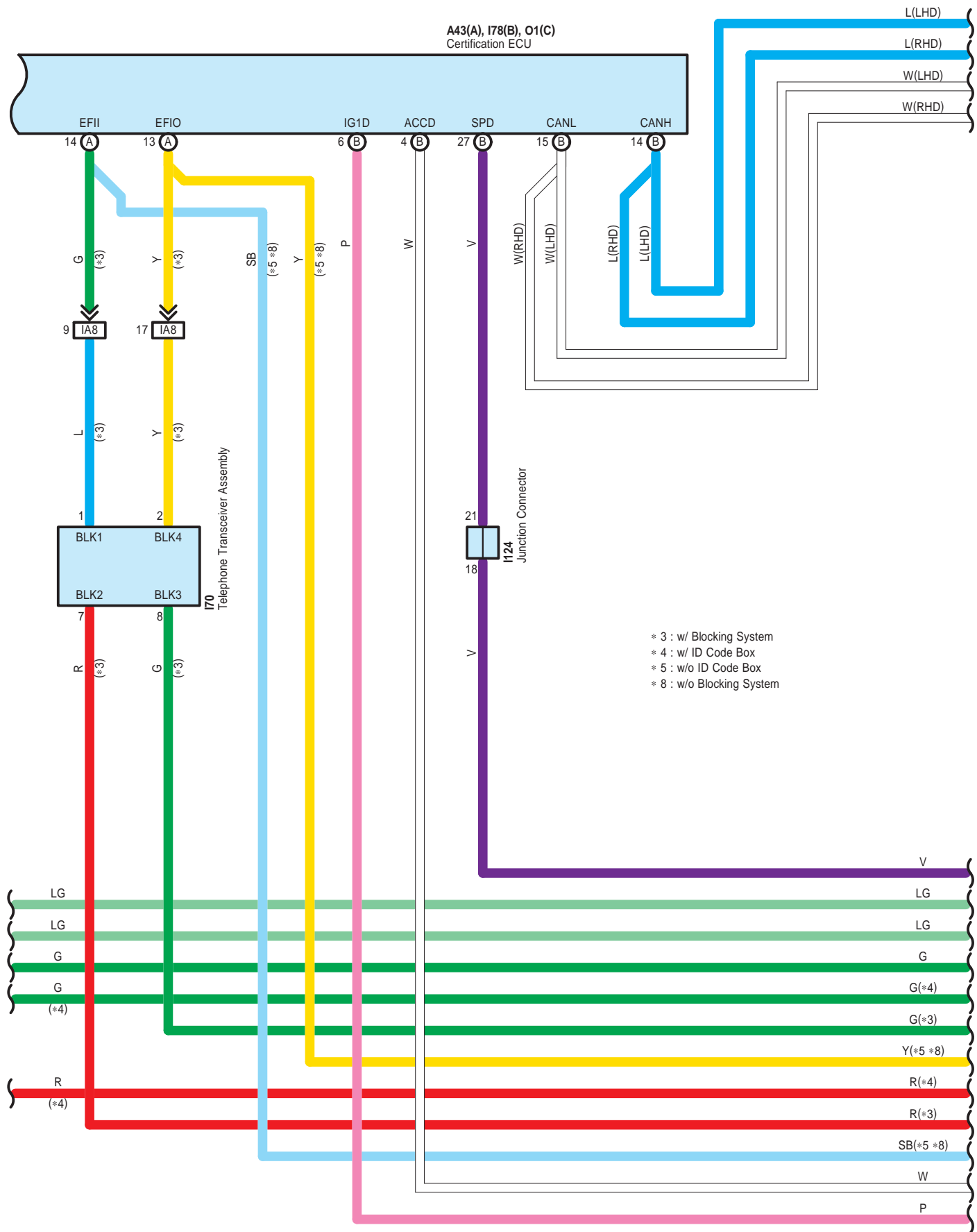

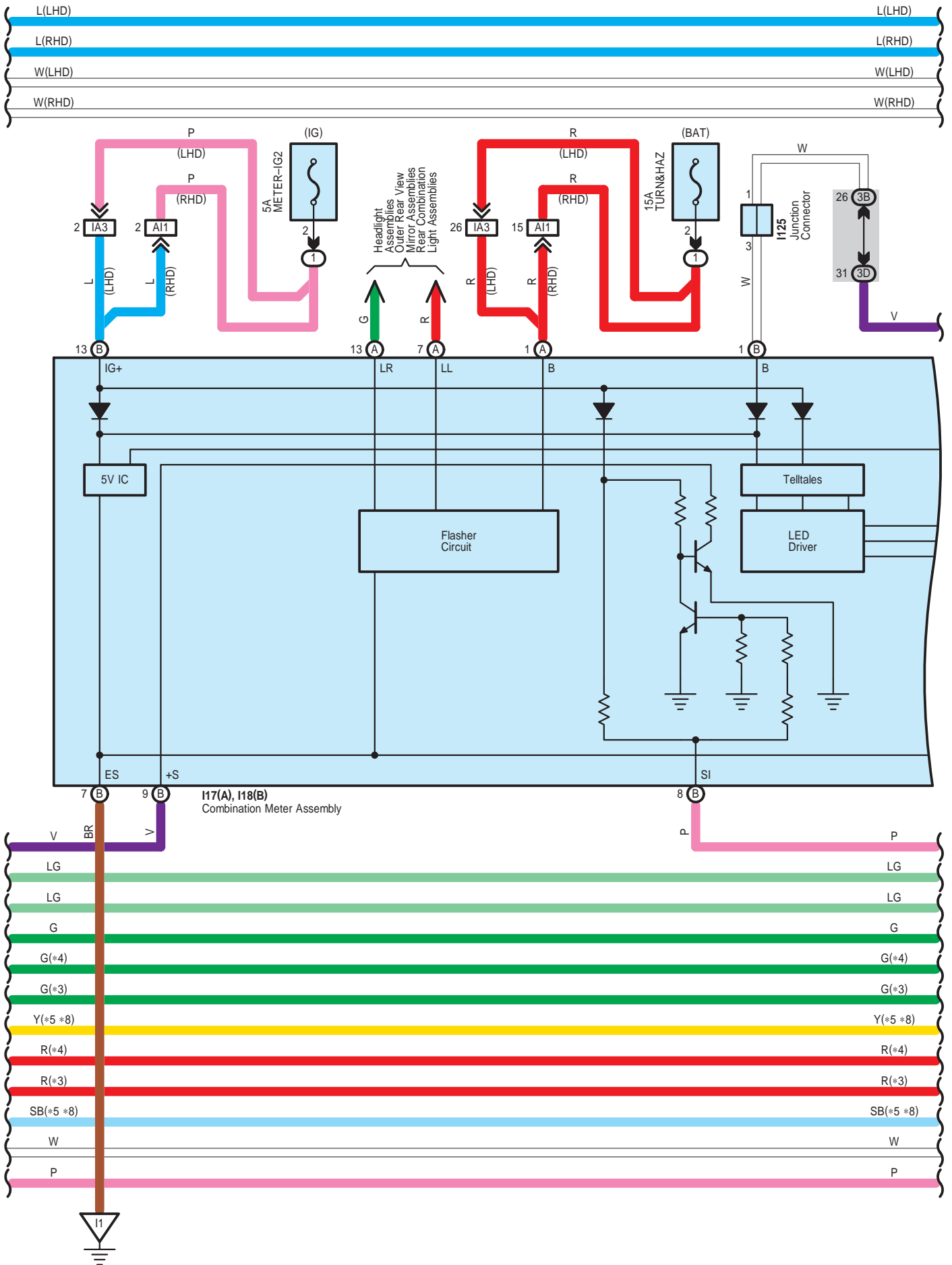

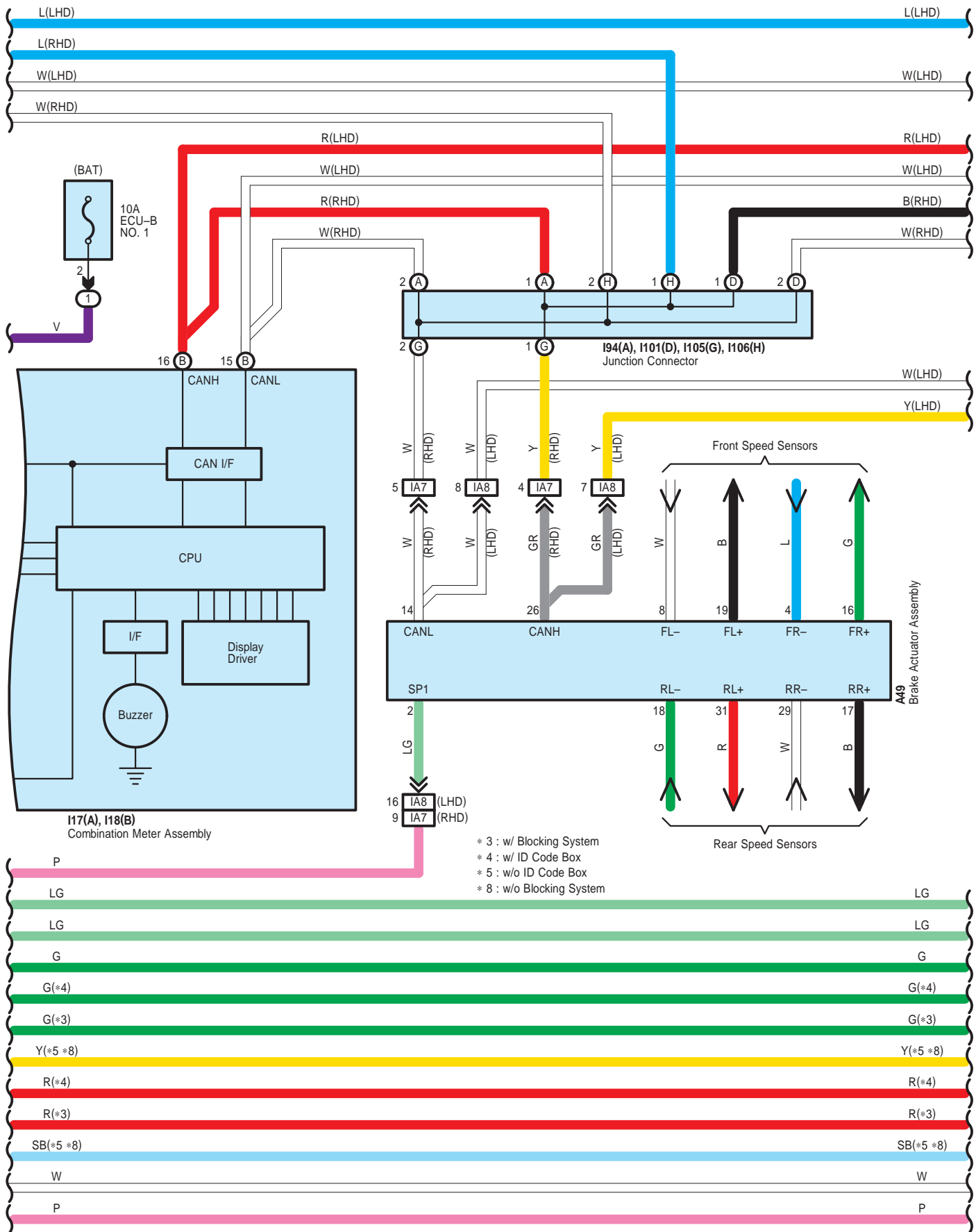

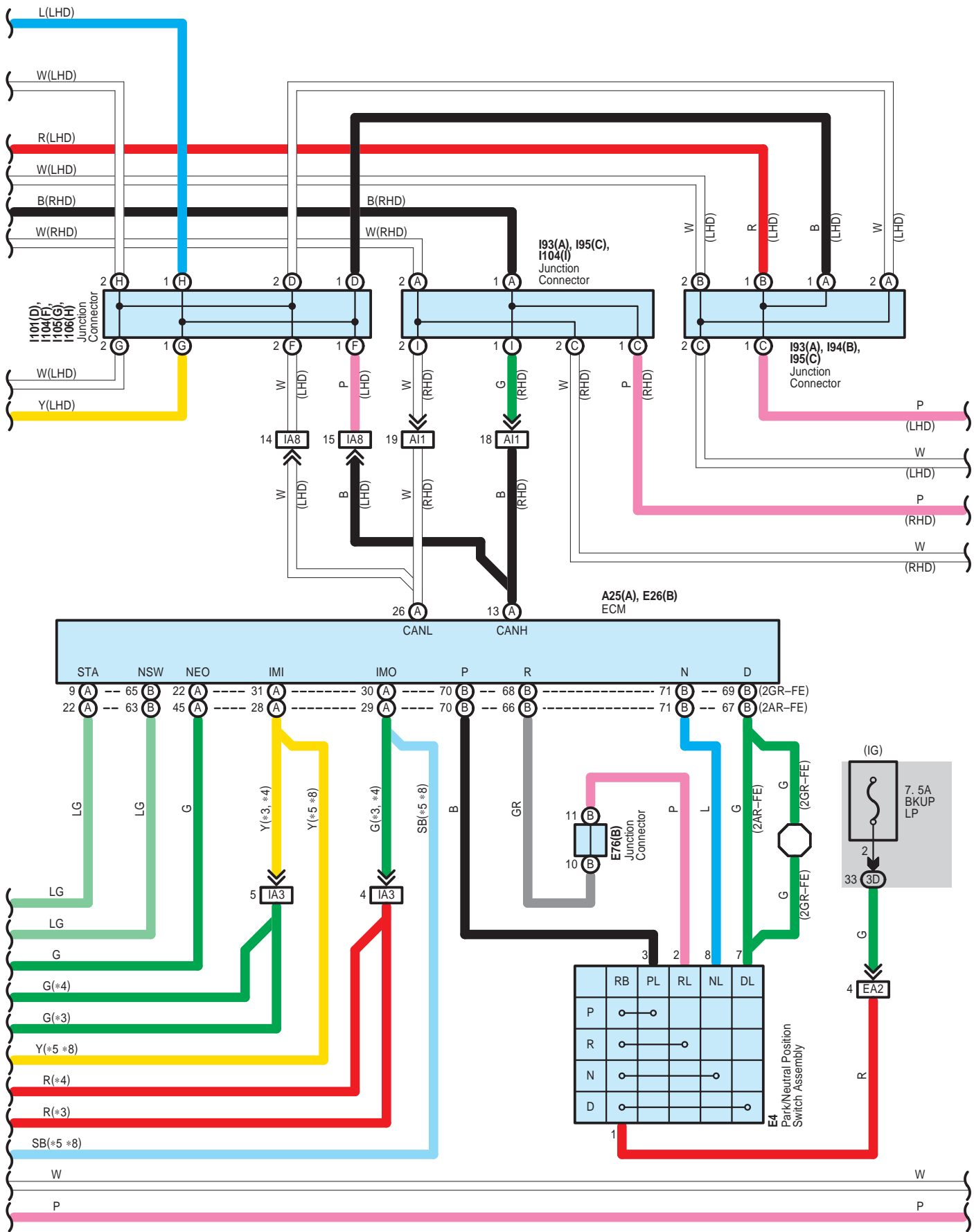

I12(A), I13(B)  
Main Body ECU

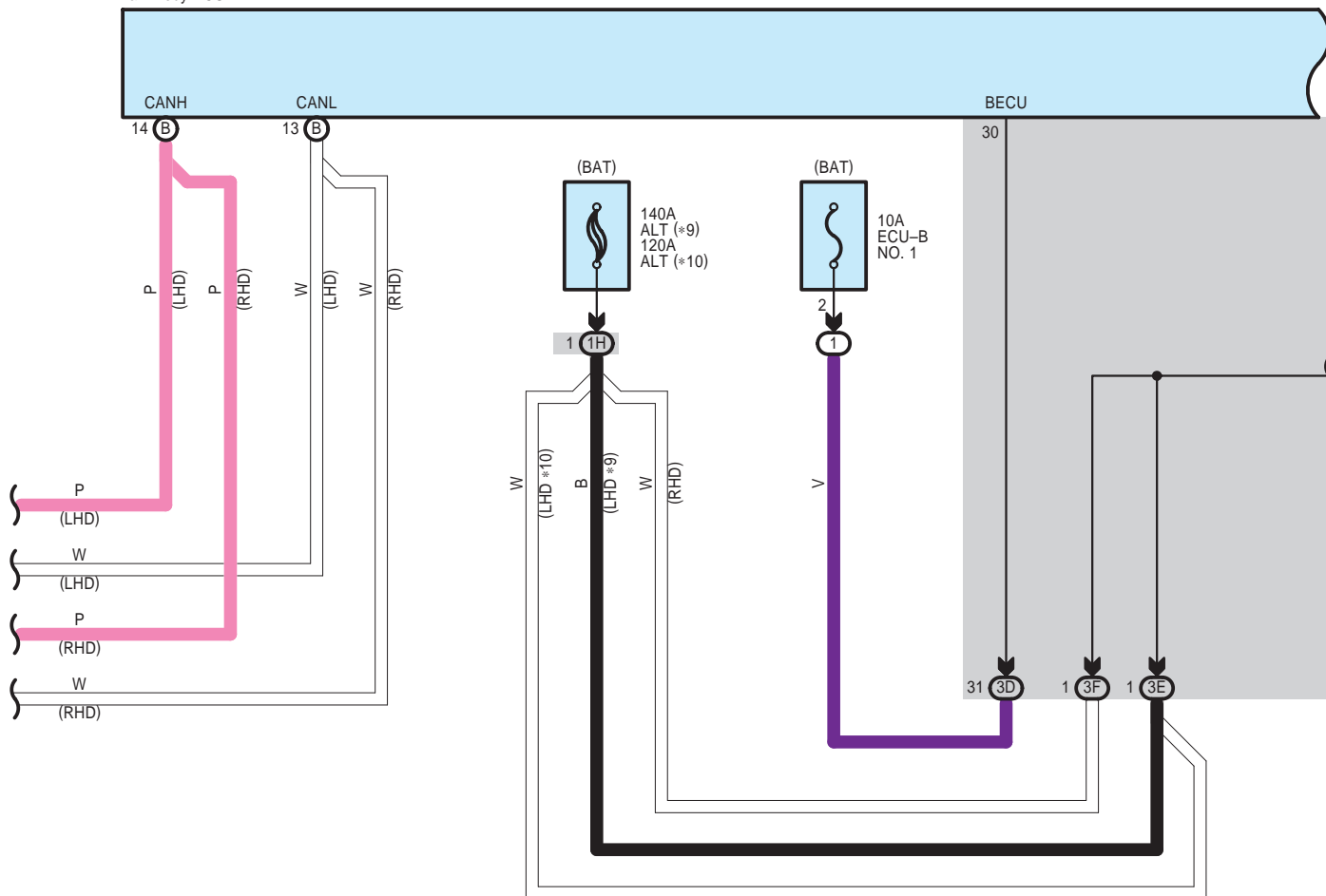

\* 9 : 130A Type Generator Assembly  
\*10 : 100A Type Generator Assembly

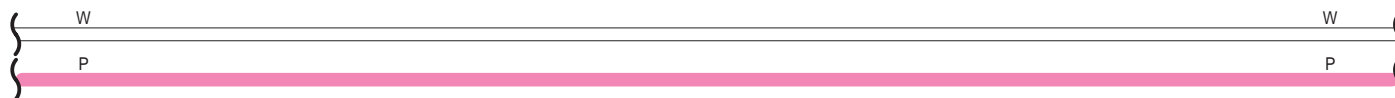

I12(A), I13(B)  
Main Body ECU

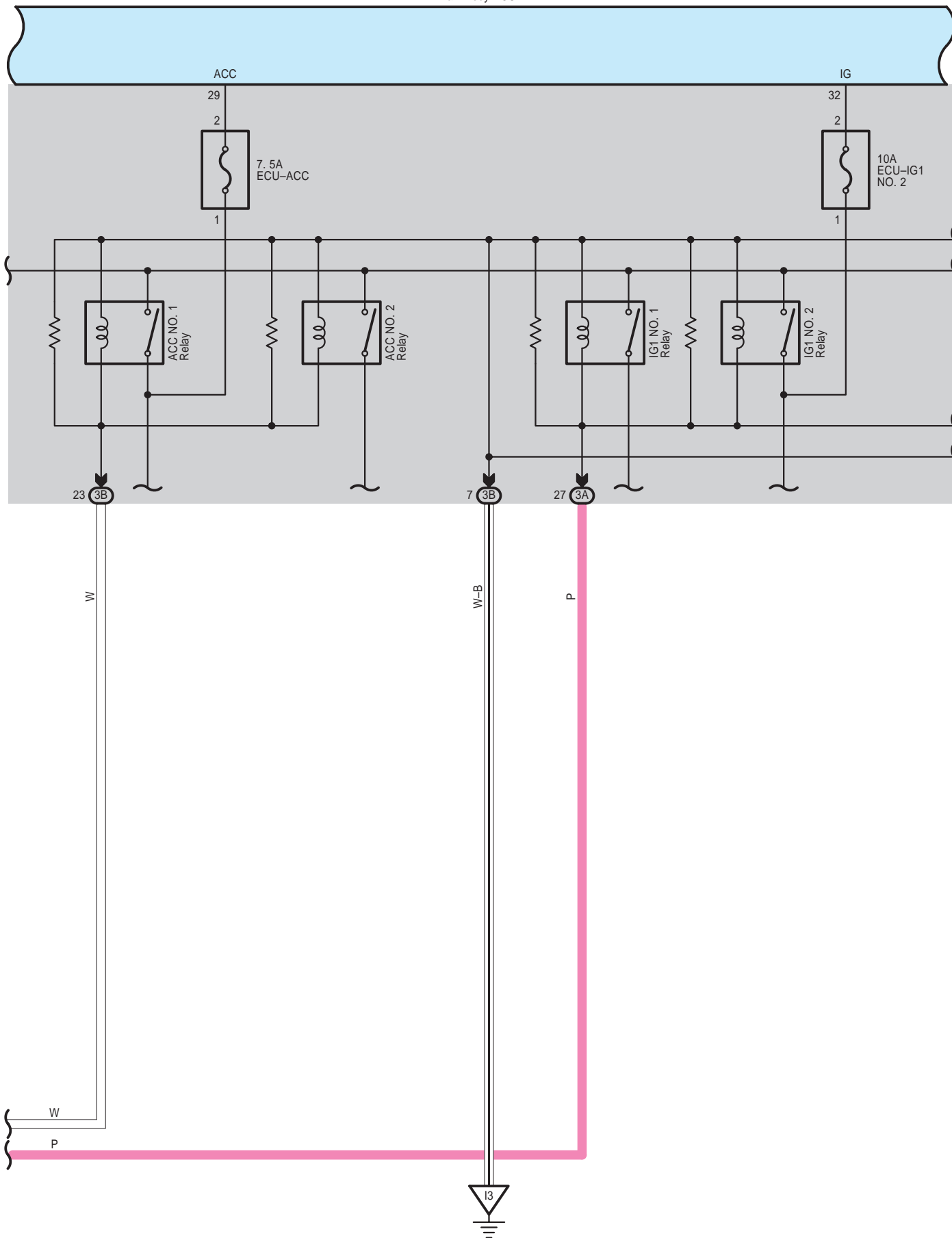

I12(A), I13(B)  
Main Body ECU

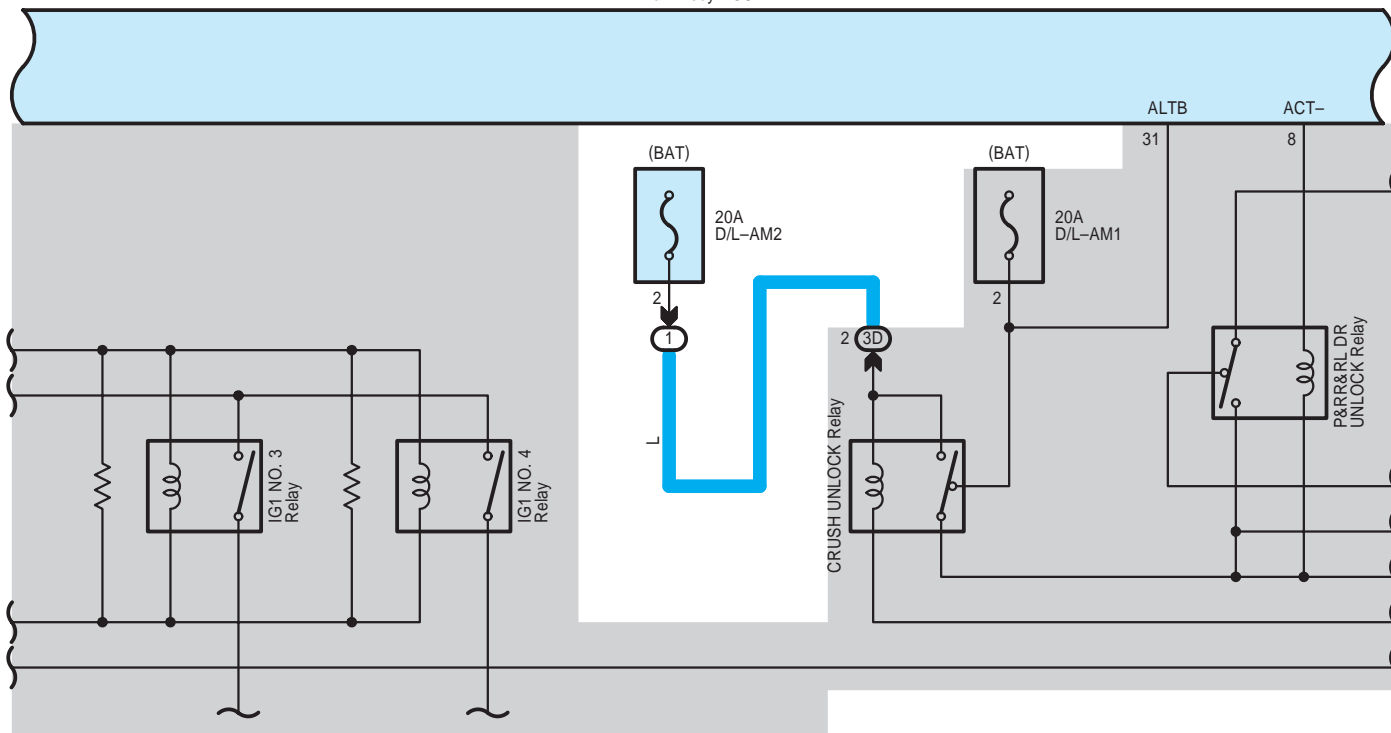

I12(A), I13(B)  
Main Body ECU

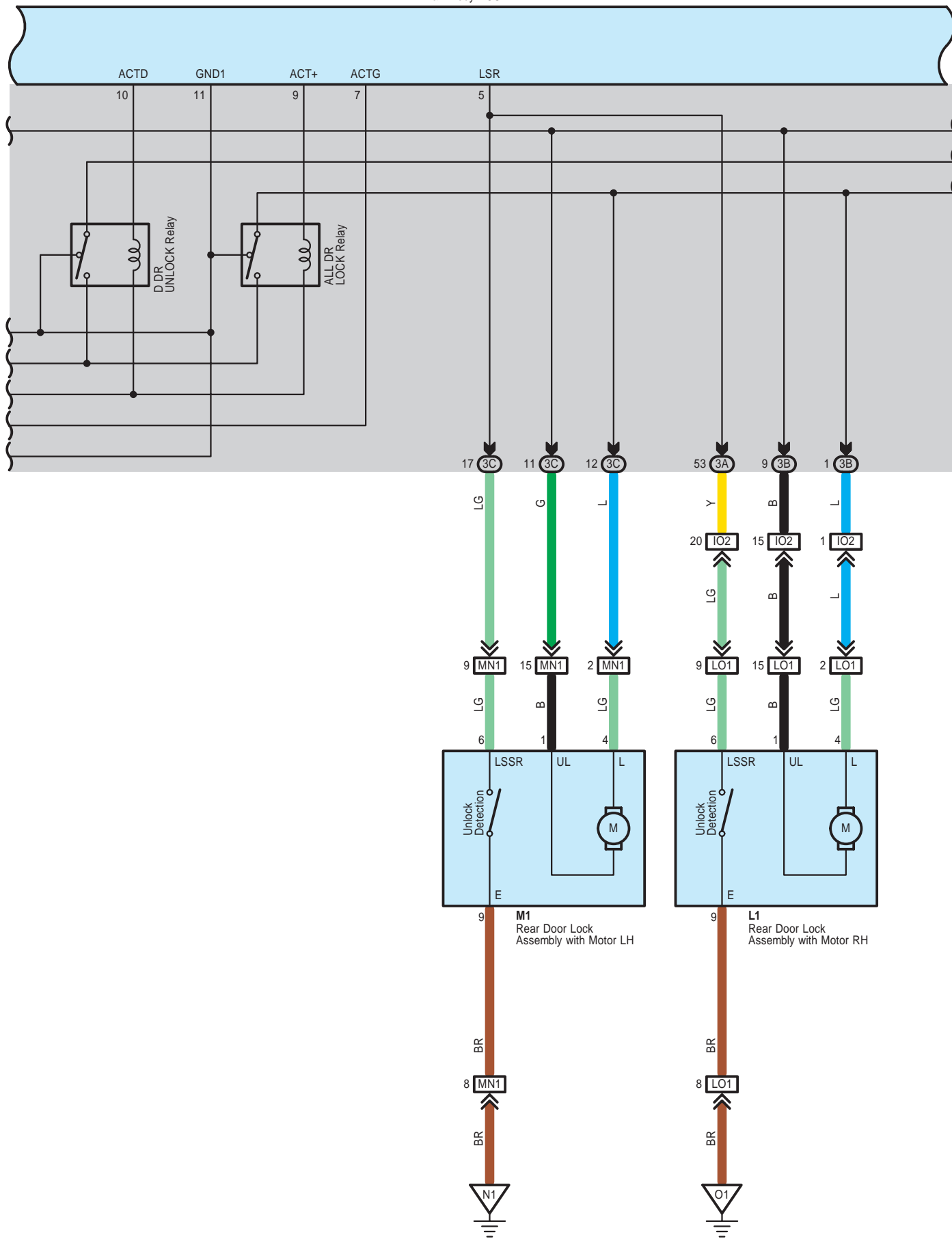



I12(A), I13(B)  
Main Body ECU

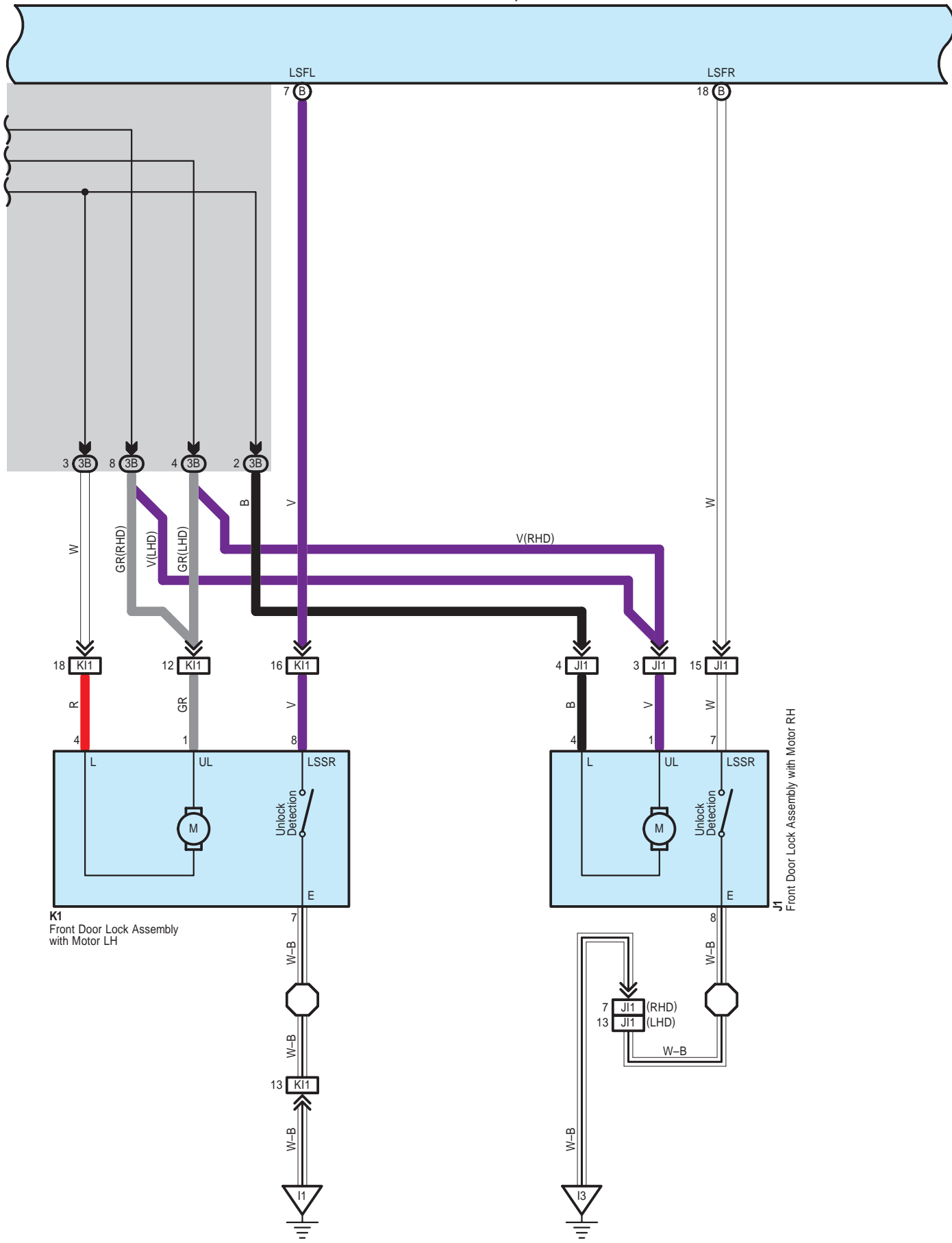

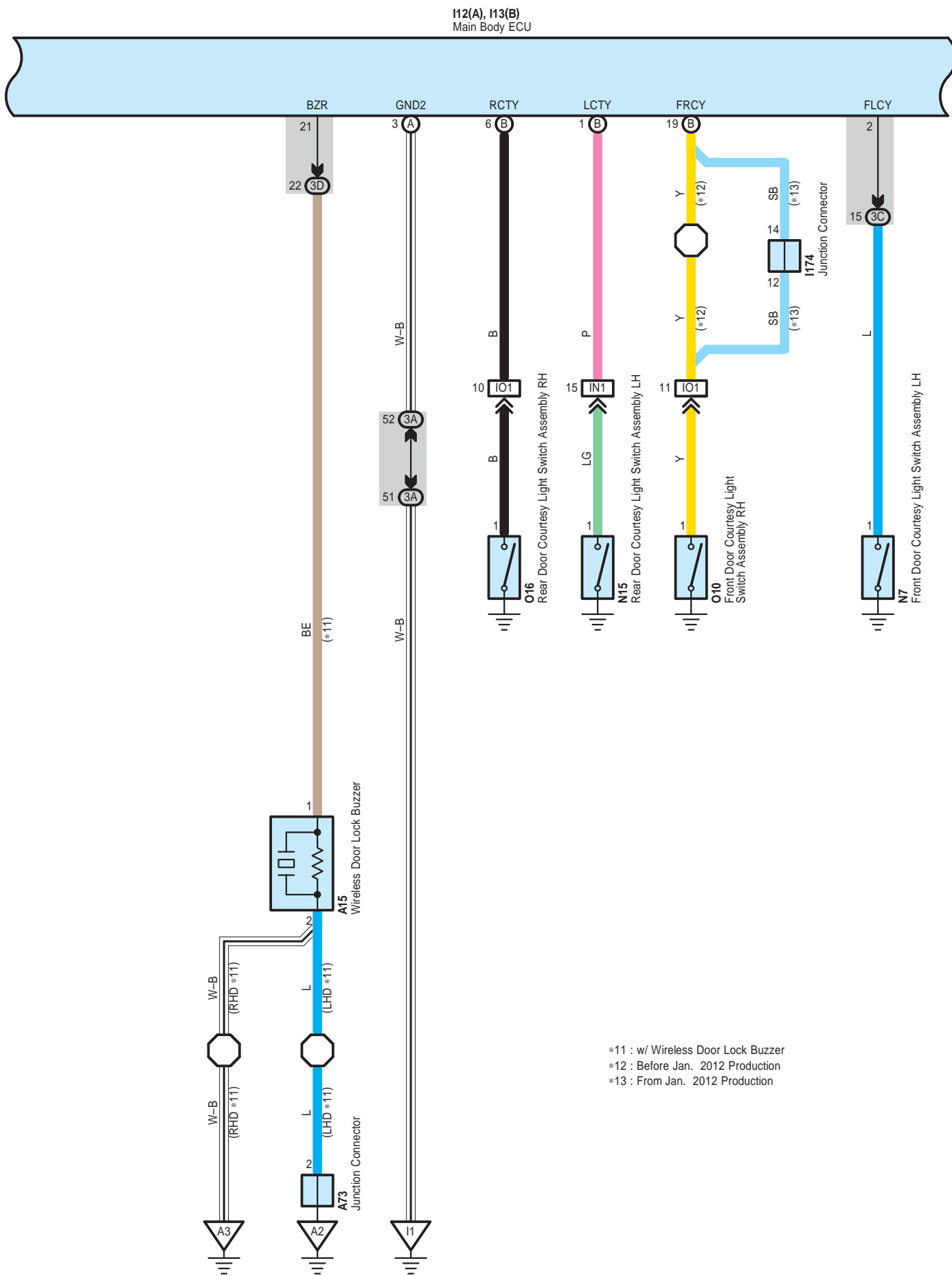

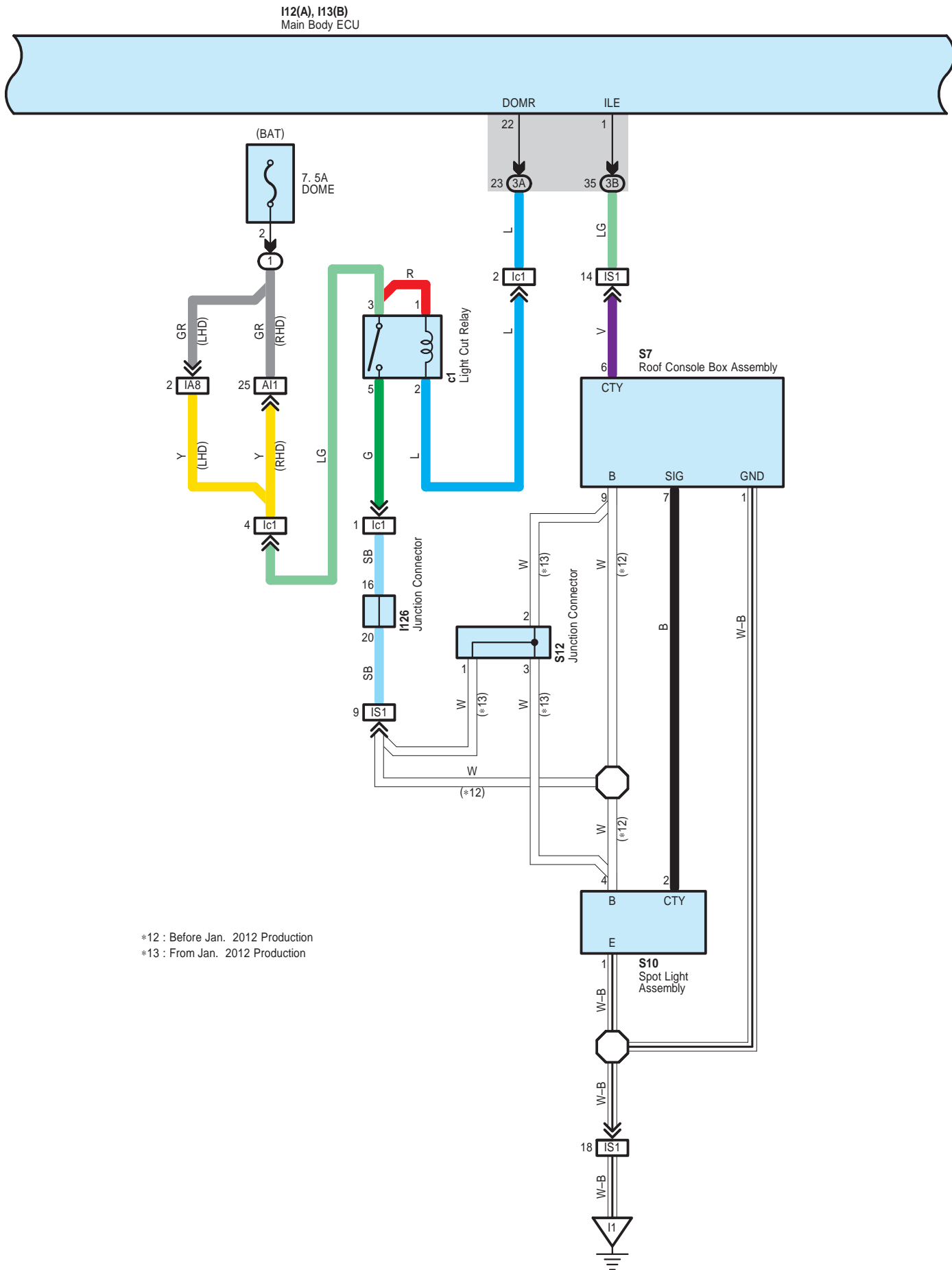

\*12 : Before Jan. 2012 Production  
\*13 : From Jan. 2012 Production

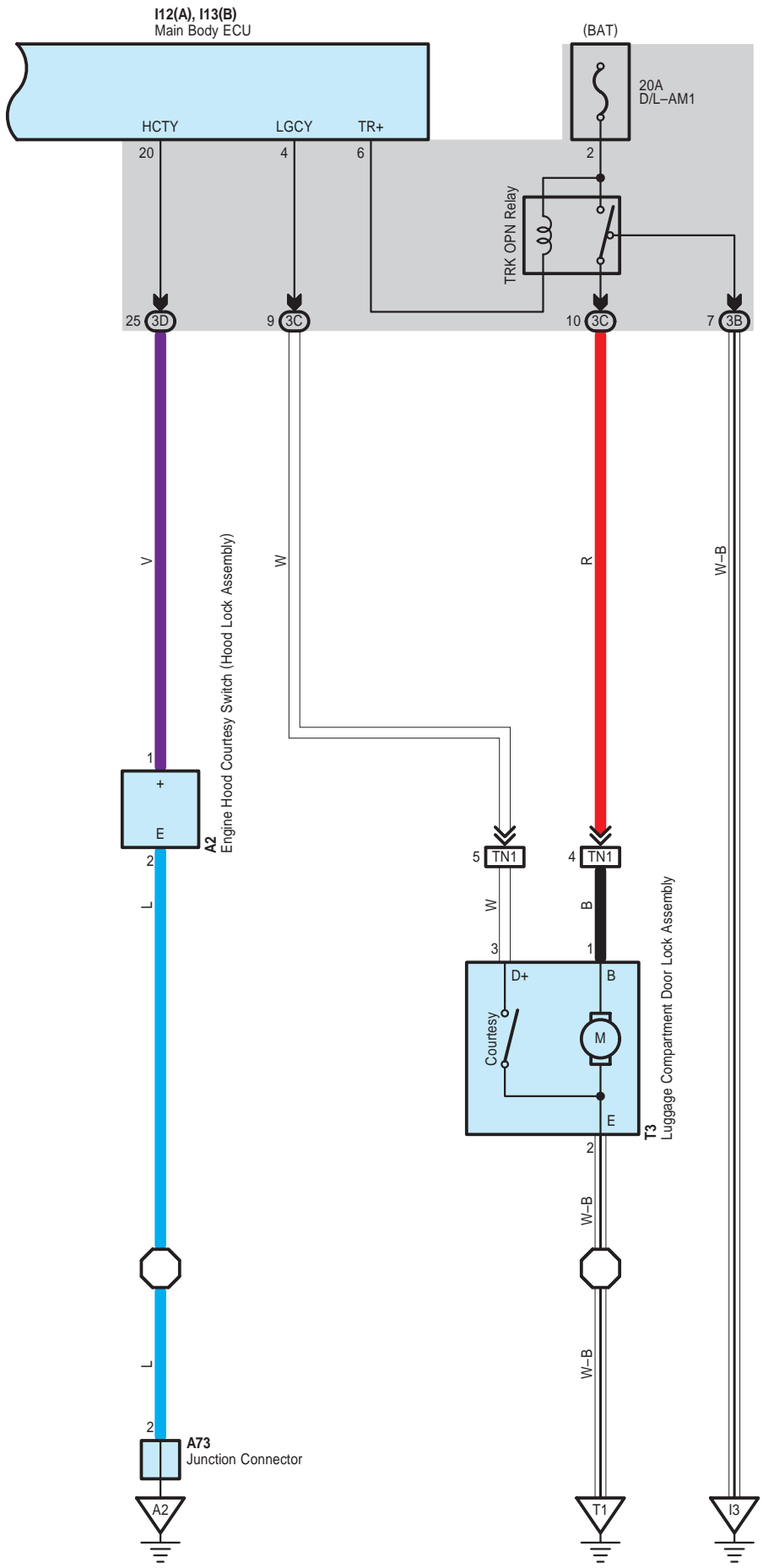

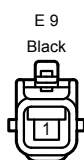
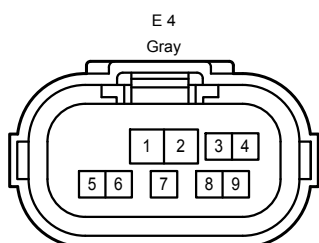
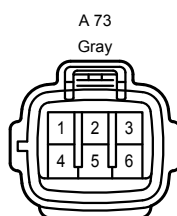
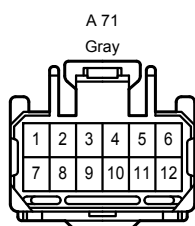
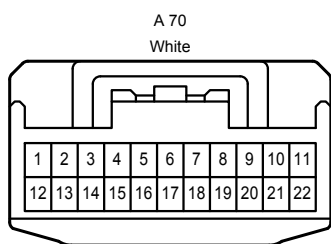
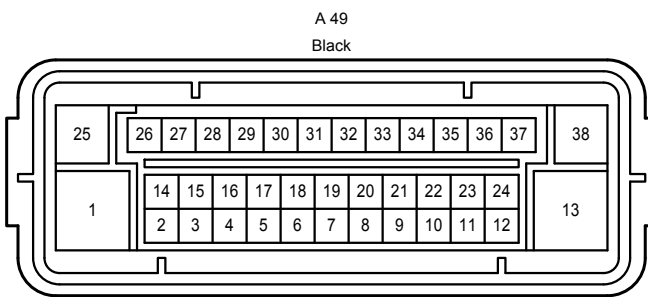
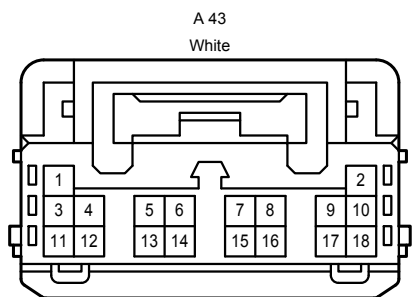
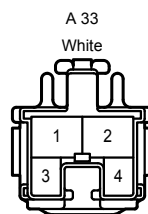
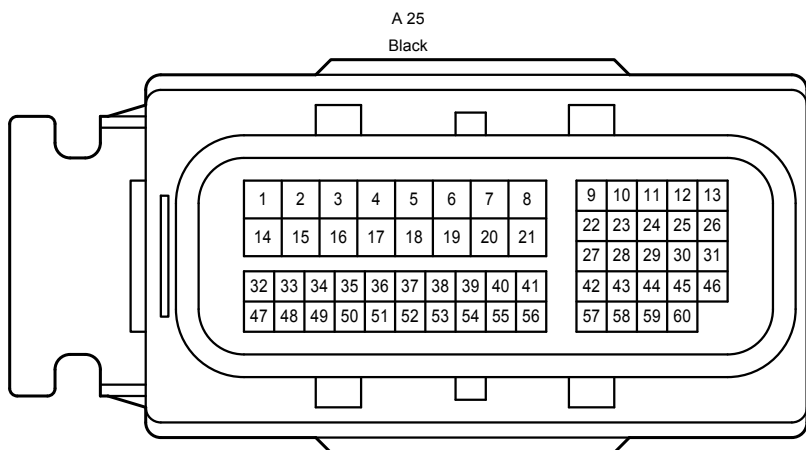
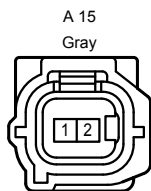

E 26  
Black

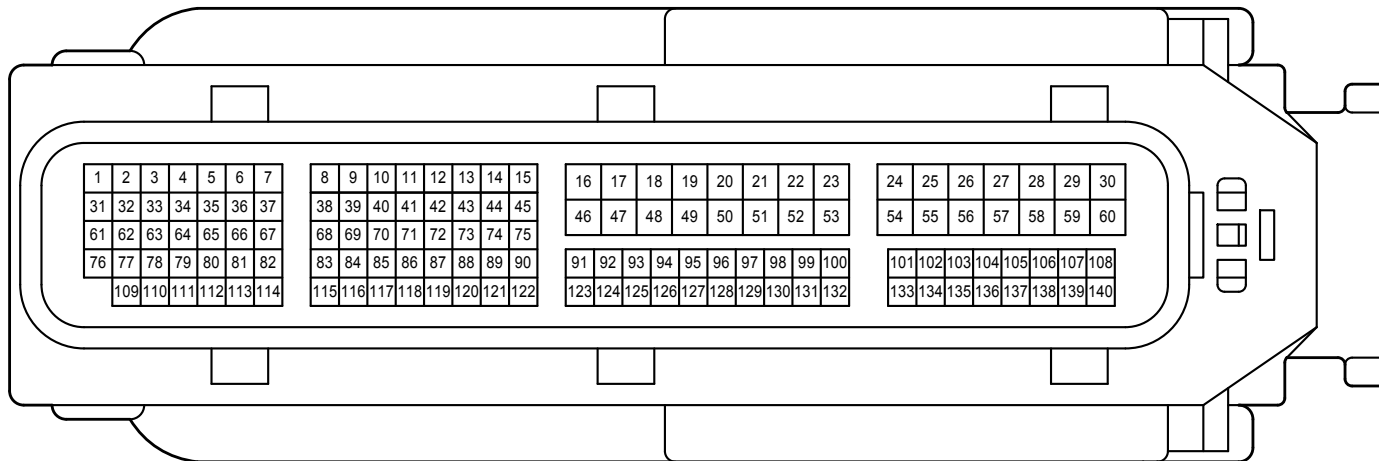

E 76  
White

F 2

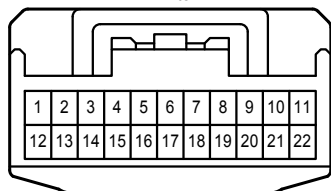

I 12  
White

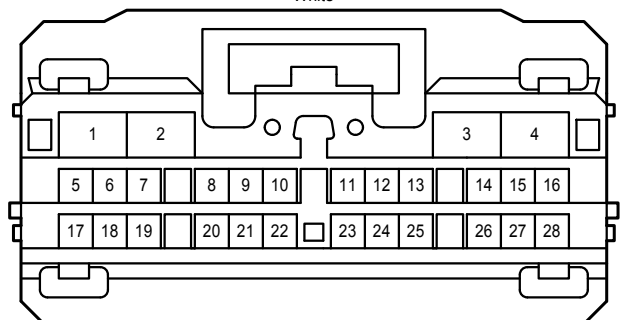

I 13  
White

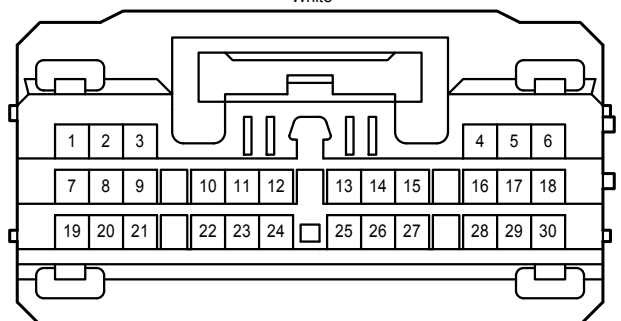

I 17  
Black

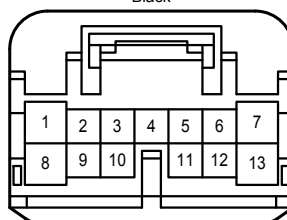

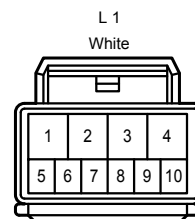
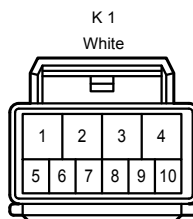
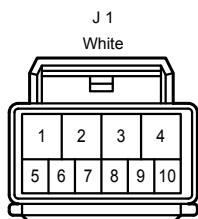
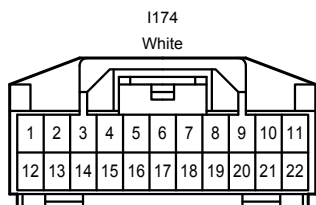
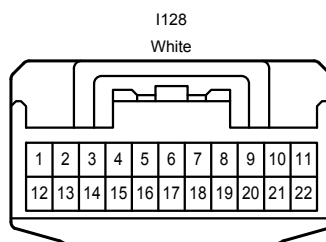
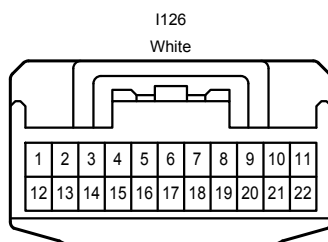
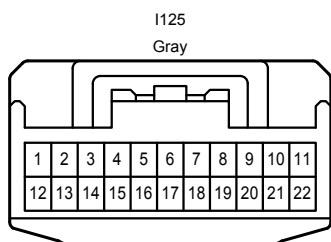
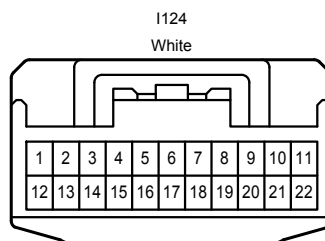
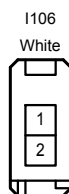
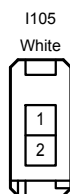
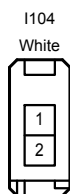
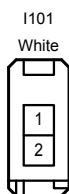
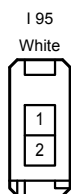
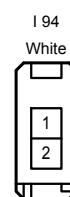
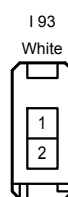
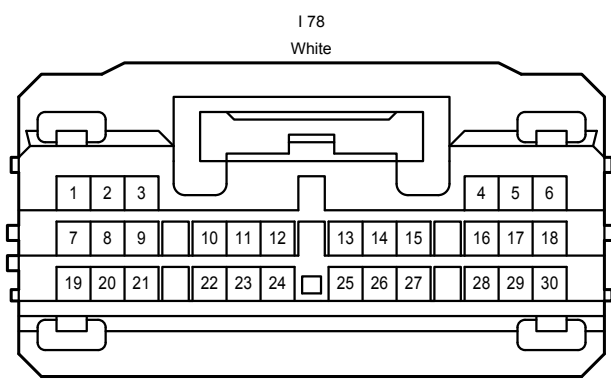
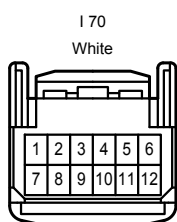
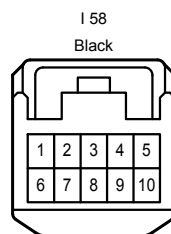
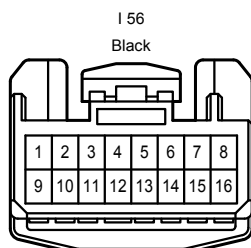
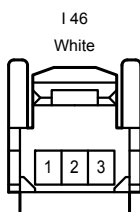
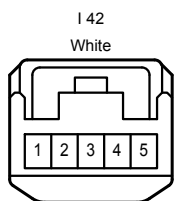
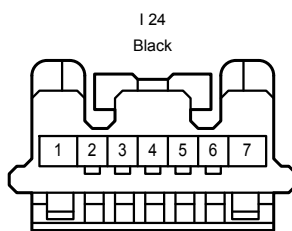
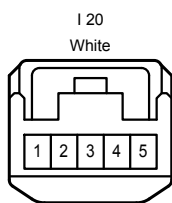
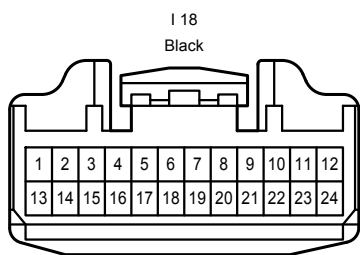

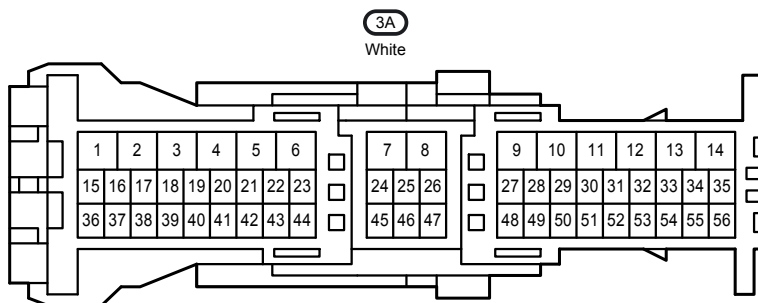
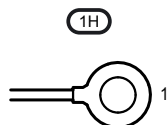
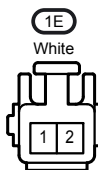
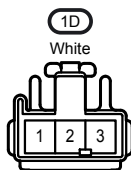
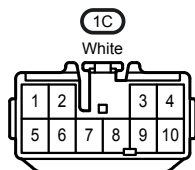
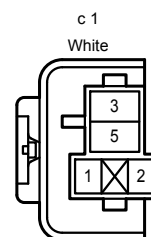
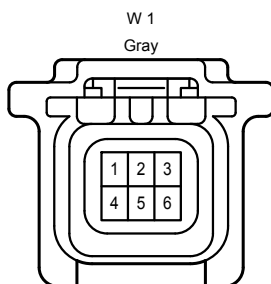
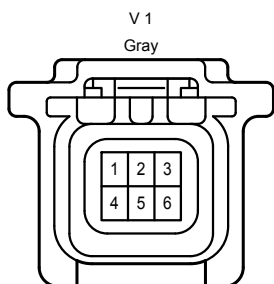
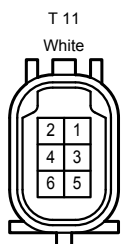
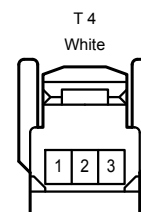
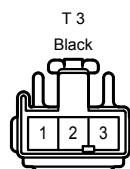
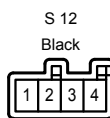
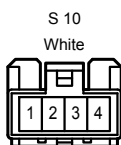
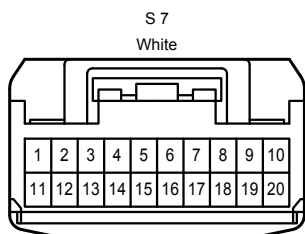
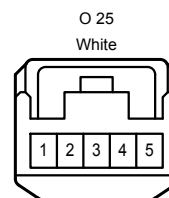
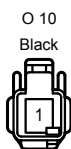
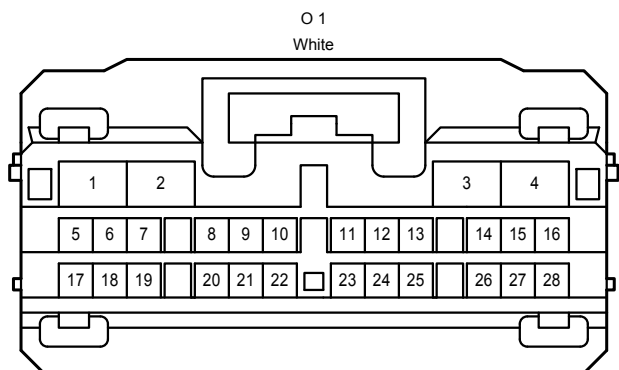
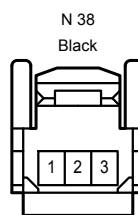
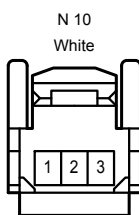
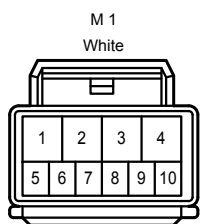



3B

White

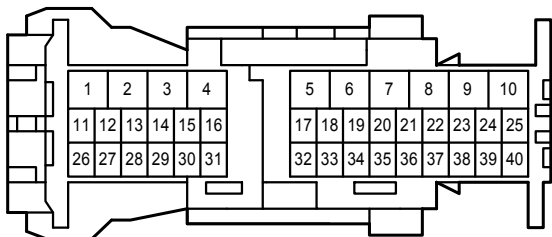

3C

White

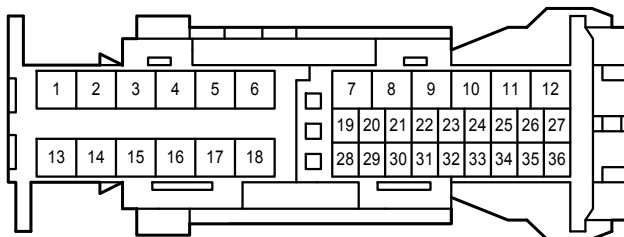

3D

White

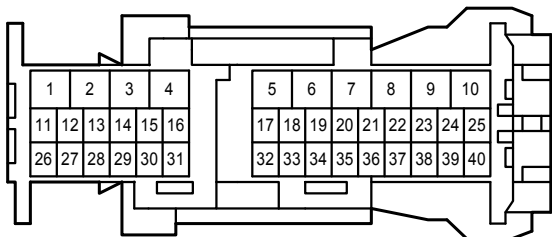

3E

White

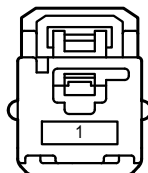

3F

White

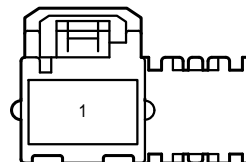

A11

White

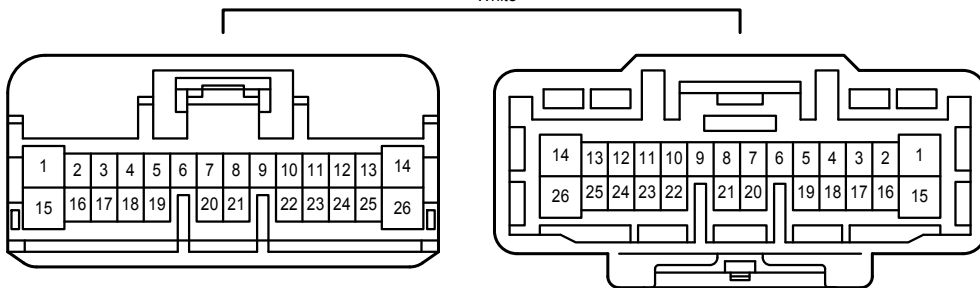

A12

White

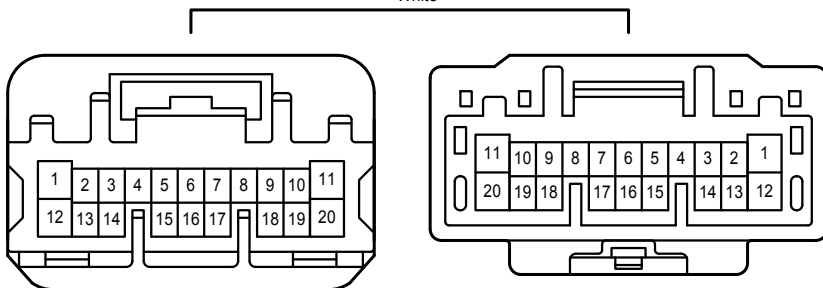

EA1

White

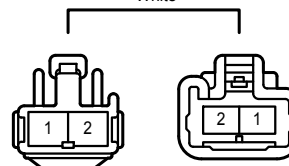

EA2

White

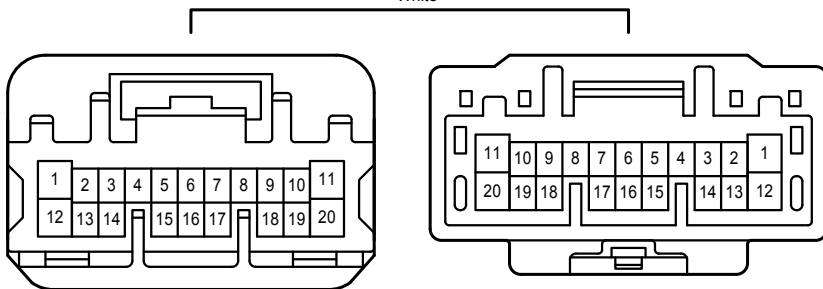

IA3  
Blue

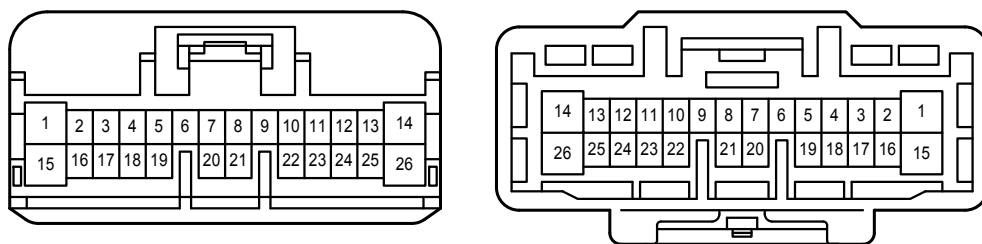

IA4  
Gray

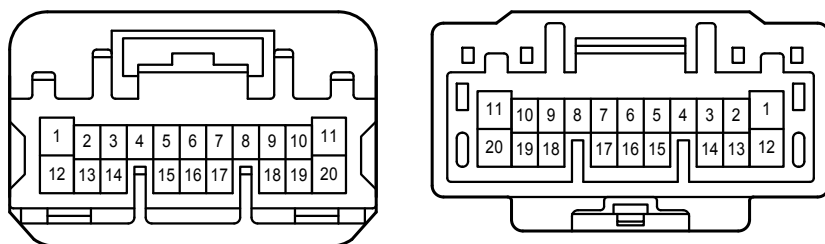

IA7  
Gray

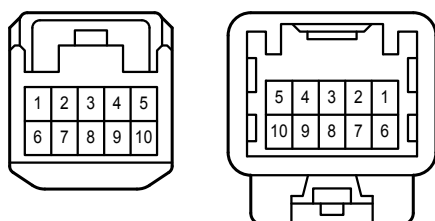

IA8  
Gray

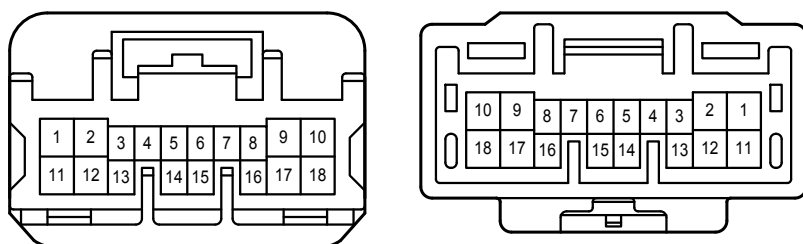

IN1  
White

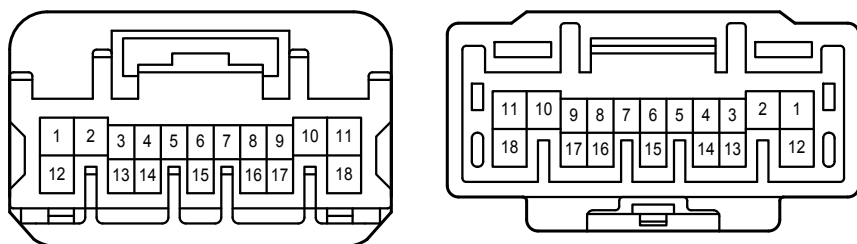

IO1  
White

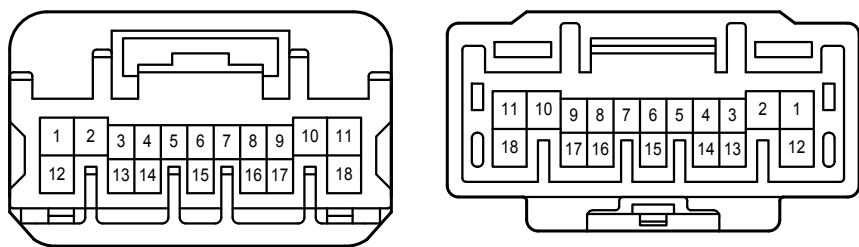

IO2  
White

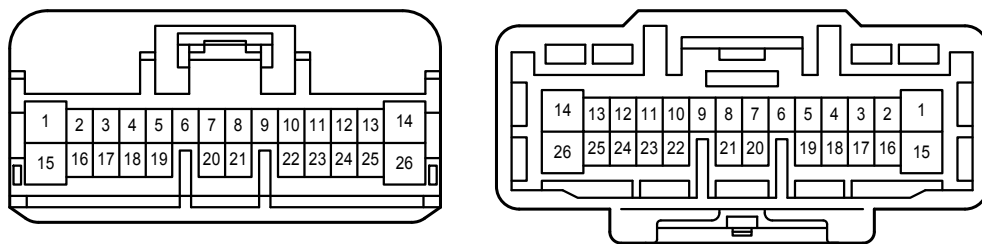

IS1  
White

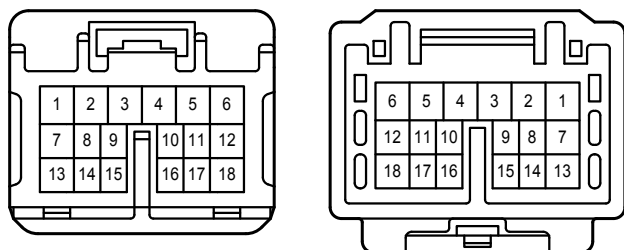

Ic1  
White

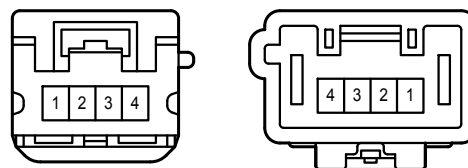

J11  
Gray

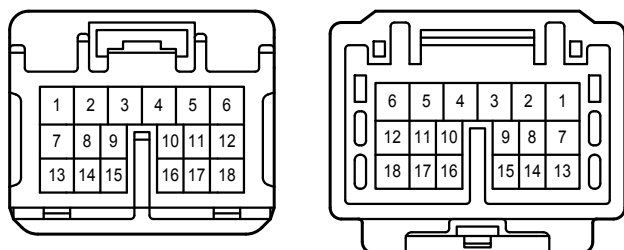

J12  
Blue

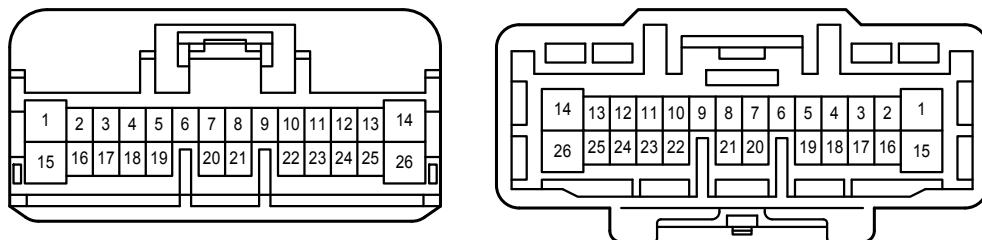

K11  
White

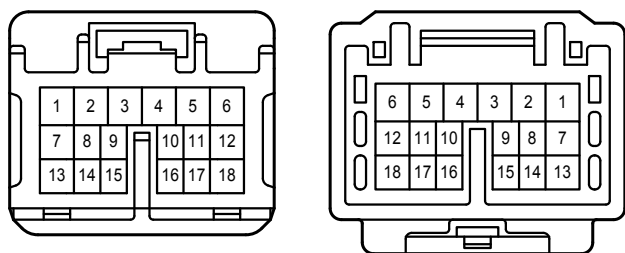

K12  
White

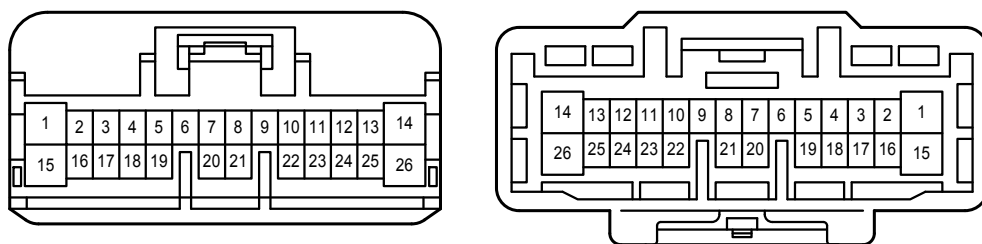

LO1  
White

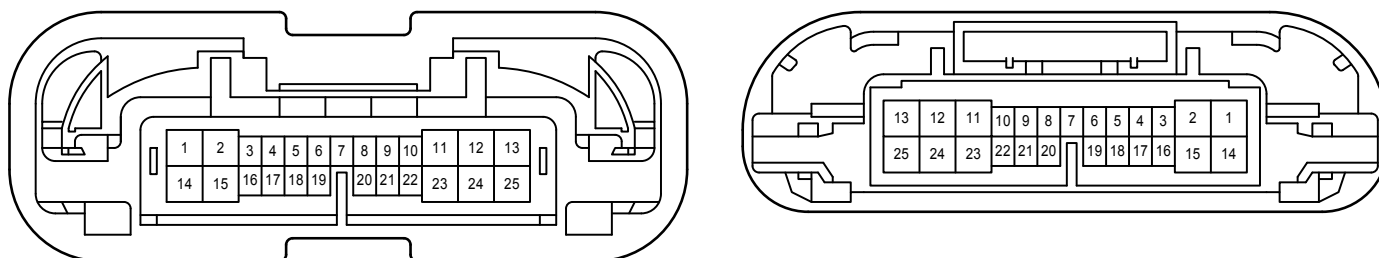

MN1  
White

